

A large, abstract red graphic on the left side of the page, consisting of several overlapping geometric shapes that form a jagged, angular shape pointing towards the bottom right.

nexus

SonaStar Handpiece
Instructions for Use

For additional information not contained in this manual, please visit www.misonix.com or contact your local sales representative.

1. General Safety Statements

WARNING The neXus® Ultrasonic Surgical Aspirator System is an electro-mechanical device, which under certain circumstances could present an electrical shock hazard to the operator and/or patient. Please read manual thoroughly and follow directions stated herein to assure maximum safety during operation. This manual shall be kept in close proximity to the system for easy referral when needed.

WARNING The neXus® Ultrasonic Surgical Aspirator System is intended to be used in various types of invasive, surgical procedures. There may be indirect danger to the patient should the device fail during the procedure. It is recommended that the facility follows its back-up equipment protocols.

CAUTION Special Skills Training Requirements

- U.S. federal law restricts this device to sale by, or on the order of a licensed healthcare practitioner.
- The NeXus® Ultrasonic Surgical Aspirator System is to be used by an appropriately trained and licensed healthcare practitioner.
- All Hospital personnel are trained in universal precautions and use of PPE

1.1. Summary of Safety Notices

Please read this section of the manual carefully. It contains a summary of all precaution, warning and caution statements contained in the manual. However, the user is advised to read the entire manual and operate the device only in accordance with all of the instructions contained herein.

Servicing of this device should only be performed by qualified technicians authorized by Misonix, Inc. There are no service controls accessible to the user.

Conventions on Warnings and Cautions	
WARNING	Denotes potentially dangerous situation that could result in death or serious injury to patient, operator or staff.
CAUTION	A caution contains information regarding any special care to be exercised by the practitioner and/or patient for the safe and effective use of the device.

Table 1.1: Conventions on Warnings and Cautions

1.2. List of Warnings

- The neXus® Ultrasonic Surgical Aspirator System is an electro-mechanical device, which under certain circumstances could present an electrical shock hazard to the operator and/or patient. Please read manual thoroughly and follow directions stated herein to assure maximum safety during operation. This manual shall be kept in close proximity to the system for easy referral when needed.
- The neXus® Ultrasonic Surgical Aspirator System is intended to be used in various types of surgical procedures. There may be indirect danger to the patient should the device fail during the procedure. It is recommended that the facility follows its back-up equipment protocols.
- Explosion Hazard: Never use the neXus® Ultrasonic Surgical Aspirator System in the presence of a flammable or explosive atmosphere, such as flammable anesthetics.
- Only use the SonaStar Long or Short handpiece with probe accessory kit configurations for the indications for use charted in Section 2.1
- Tip and irrigation temperatures may exceed the tissue necrosis point if insufficient irrigation flow rates are used. For hard tissue removal, set the irrigation flowrate to a setting no less than the comparable vibration setting. For example, if the vibration setting is 70, a minimum flow setting of 70% should be used. Additional external irrigation, e.g. by administering sterile saline with a syringe over the distal tip portion, may be necessary for removal of very dense, hard osseous structures.
- Tissue necrosis may result if tip is not moved relative to tissue. A continuous, lateral sweeping motion is recommended in order to minimize contact duration with the ultrasonic tip and minimize heat build-up. When lateral motion is not possible withdraw and re-insert tip frequently.
- Contact to vibrating elements like extension and ultrasonic tip may cause burns and should be avoided by all means. The handpiece should only be held at the black housing area. An optional, protective silicone sleeve, included with certain tips, reduces the risk of thermal damage but does not eliminate it. Contact with the silicone sleeve should be avoided or kept brief with minimal amount of contact pressure. Pressure and extended exposure can still result in excessive frictional heat and cause burns.
- Ultrasonic tips can break under excessive use in extreme conditions, e.g. when cutting for extended / duration in tight cavities with limited lateral motion. The tip could break into two or more fragments with the main fragment remaining attached to the handpiece. All fragments must be retrieved immediately from the surgical site. The fragments should be checked to ensure that no further pieces are missing. It is possible that a fragment is propelled outside of the surgical cavity. Diagnostic imaging, such as X-ray, must be used if a fragment cannot be found to confirm that the broken piece is outside of the surgical cavity.
- Breakage of ultrasonic tips will result in sharp edges that can be harmful to soft tissue even without activation of ultrasound. Tips can bend or deform before they actually brake. Tips showing signs of deformation or cracking should be replaced immediately since tip breakage is otherwise imminent. Do not bend or twist the ultrasonic tips since it reduces the structural integrity and can result in tip breakage during use. Dispose of deformed or broken tips immediately in a sharps container.
- Improper connection of the handpiece cable may present a shock hazard. Confirm that handpiece connector is dry prior to plugging it in.

- The neXus Long or Short Handpieces can deliver RF energy via its attached probe tip when connected to a 3rd party electrosurgical generator using the RF Monopolar Handswitch Cable accessory. Misonix recommends use of the electrosurgical generators listed in Table 4.5 that have been validated for compatibility with the neXus system.
- DO NOT use any electrosurgical device that exceeds a peak electrosurgical output of 4.5KV in the coagulation mode (COAG) to avoid electrical shock.
- Improper assembly of Single-Use Monopolar Handswitch Cable to endcap can expose potentially dangerous electrosurgery voltage. To avoid poor electrical connection, always make sure the Single-Use Monopolar Handpiece Cable socket is firmly and fully engaged onto the pin in the endcap. Inspect the silicone sleeve near the probe tip for cracks that may expose the probe (active electrode)
- Improper connection of the RF monopolar fingerswitch cable may present a shock hazard. Always use gloved, dry hands when plugging it in to the electrosurgical generator and handpiece.
- Always place the neXus SonaStar handpiece with the monopolar handpiece cable attached on a nonconductive surface when not in use for monopolar cautery.
- Always use the lowest possible generator setting that will achieve the desired cauterization effect. When higher than necessary voltages are used, the potential for arching are increased.
- Clean the neXus SonaStar tip frequently when using the tip for electrocautery. As eschar builds up on the tip, electrical impedance increases, and this can cause arching, sparking or ignition and flaming of the eschar. Clean with a nonabrasive sterile pad to prevent scratching of the probe tip. Scratch groves will increase eschar build up and can effect ultrasonic surgical performance of the tip.
- Do not wrap the neXus monopolar cable around metal instruments with sharp corners or features that can damage the cable and cause electrical shock and/or loss of function.
- Heat is being generated at the tip/tissue interface. A continuous, lateral sweeping motion is recommended for general bone/tissue removal in order to minimize contact duration with the ultrasonic tip and minimize the temperature increase.
- Remove probe cover, ultrasonic tip and extension from the handpiece prior to cleaning and/or sterilization; otherwise proper cleaning/sterilization may be inhibited.
- Single-use items (tips, sheaths, tubing sets) are marked with the international symbol for “do not reuse - single use only” (☒). Discard these items following each surgical procedure in accordance with the hospital protocol for biohazardous waste. Tips are to be disposed of in a biohazardous sharps container.
- All reusable handpiece parts and accessories must be properly decontaminated, cleaned and sterilized before each use as per instructions contained in this manual. Failure to do so may lead to infections, which can ultimately cause patient death.
- Misonix Inc. has validated all cleaning and sterilization cycles given in this manual. It is highly recommended that the procedures given in this manual for cleaning and sterilizing the neXus® Ultrasonic Surgical Aspirator System and related accessories be followed. It is the responsibility of the user of this device or any accessories used with it to validate procedures for cleaning and/or sterilization if they differ from the procedures as outlined in this manual.

- The disposable items are intended for one procedure only (single use). Do not attempt to reuse or re-sterilize.
- The neXus® Ultrasonic Surgical Aspirator System and its accessories may emit harmful acoustic pressure if exposure exceeds recommended limits.
=
- No Modifications of this equipment is allowed except as noted for cleaning and sterilization. The user should return to Misonix or an authorized service center.

1.3. List of Cautions

- Special Skills Training Requirements
 - U.S. federal law restricts this device to sale by, or on the order of a licensed healthcare practitioner.
 - The neXus® Ultrasonic Surgical Aspirator System is to be used by an appropriately trained and licensed healthcare practitioner.
 - All Hospital personnel are trained in universal precautions and use of PPE.
- The use of accessories, transducers and cables other than those specified may result in increased emissions or decreased immunity of the device. Use only Misonix branded equipment and accessories.
- Ultrasonic energy is inhibited if excessive physical force is applied to the ultrasonic tip; use only enough force to guide the tip to the surgical site and to advance it through the tissue. Do not force the tip; allow the ultrasonic action to do the work.
- This Instructions for Use Manual provides instructions on using the neXus SonaStar Handpiece. Refer to the neXus Console Instructions for Use Manual prior to using the neXus Ultrasonic Surgical Aspirator System.
- Insufficient irrigation and high tip pressure (loading) under extended exposure, e.g. in tight cavities, are to be avoided while removing hard tissue. It is recommended to withdraw and re-insert the ultrasonic tips (e.g. Blades & Shavers) repeatedly to re-establish adequate cooling and lubrication.
- Additional external irrigation, e.g. by administering sterile saline with a syringe over the distal tip portion, may be necessary when removing very dense, hard osseous structures.
- All reusable system components like handpiece, probe covers, counter wrench, and T-wrench are supplied industrially cleaned, but NON-STERILE. All items intended for use in the sterile field must be cleaned and sterilized as per the indicated instructions before first clinical use and before every subsequent clinical use.
- All items intended for use in the sterile field must be cleaned and sterilized as per indicated instructions before each clinical use.
- The disposable items are intended for one procedure only (single use). Do not attempt to reuse or re-sterilize.
- Prime the irrigation tubing prior to use. At all times ensure that the irrigation flows towards the handpiece when footswitch is depressed. If no irrigation is flowing, cease use until flow is restored.
- The system check should always be done in advance of preparing patient for surgery to minimize risk to patient in case of system malfunction.
- Ensure all connections and mating surfaces of handpiece, extension and ultrasonic tip are clean and dry before assembly.
- Do not use ultrasonic cleaners to clean the handpiece as this method could damage handpiece.
- Be certain to clear debris from all internal passages by brushing. Failure to do so may hinder sterilization of units during autoclaving.

- Do not immerse ultrasonic console, handpiece, irrigation pump, or electric cables. These items are not sealed against liquids and damage to equipment will result.
- Ensure all connections and mating surfaces of handpiece, extension and ultrasonic tip are clean and dry before assembly.
- Studies have shown that smoke generated during electrosurgical procedures can be potentially harmful to patients and the surgical team. These studies recommend adequately ventilating the smoke by using a surgical smoke evacuator or other means. Refer to the 3rd party electrosurgical generators user manual for more information regarding the evacuation of smoke.
- Loose tip/tissue contact upon an initial bone incision can cause a thin tip to resonate not only longitudinally but also transversely. This can cause a thin tip to break. It is necessary to engage bone actively and with a minimal tip pressure greater than zero in order to prevent the shattering.
- Contact of the ultrasonic tip or the exposed extension with metal, surgical instruments or other objects during ultrasound use must be avoided. Such contact can damage the ultrasonic components very easily and may result in compromised performance, including failure. Discard any extensions or tips that show signs of damages like gouges, nicks or fractures. External aspiration may be used but it is recommended that a plastic suction tip should be used when in proximity with the probe tip.
- The handpiece must be placed into the counter wrench. Do not attempt to tighten or loosen handpiece components by holding the handpiece case or endcap. Always use the T-wrench wrench when tightening or un-tightening the tip or an extension. Never apply a pipe or strap wrench to the handpiece case. Do not over-tighten the tip or the extension.
- Always tighten or un-tighten the probe cover by hand and without using any wrenches. Do not over-tighten the probe cover.
- Always hold the handpiece at its metallic endcap when tightening or un-tightening the irrigation tubing. Always tighten or un-tighten the irrigation tubing by hand and without using any wrenches. Do not over-tighten the tubing connector.
- Allow reusable, autoclavable items to gradually return to room temperature after steam sterilization and prior to usage.
- The reuse life given takes into account wear and tear due to cleaning and sterilization only. Damage or wear caused by actual use in treatments will affect life of components.

1.4. Trademark Information

- Misonix®, SonaStar® are registered trademarks of Misonix, Inc., Farmingdale, NY
- ASP Enzol® and Prolystica® are registered trademarks of STERIS Corporation, Mentor, OH

1.5. Explanation of Symbols













	Misonix CE number
	Contains DEHP and/or Phthalates
	Caution: Consult accompanying documents
	Restricted to sale by or on the order of a physician only
	Manufacturer
	Consult Instructions for Use
	Sterilized using Ethylene Oxide
	Lot or Batch Code
	Authorized Representative
	Warning: Hearing Protection
	Disposal to be compliant with EN 50419 (WEEE directive)
	Catalog number

Table 1.2: Symbol Definitions

2. Indications and Contra Indications

2.1. Indications

The Misonix Inc. **neXus**[®] Ultrasonic Surgical Aspirator System is intended for the fragmentation, emulsification and aspiration of both soft and hard (i.e.bone) tissue. The indications for use for the for the SonaStar Long and Short Handpieces in combination with SonaStar probe kit accessory configurations are charted below.

NEXUS INDICATIONS FOR USE BY HANDPIECE AND PROBE KIT ACCESSORY COMBINATION
Long and Short Handpiece for use with SonaStar[®]
Indications for Use SonaStar[®]
Indicated for use in the fragmentation, emulsification and aspiration of both soft and hard (i.e. bone) tissue in the following surgical specialties: <ul style="list-style-type: none">• Neurosurgery• Gastrointestinal and Affiliated Organ Surgery• Urological Surgery• Plastic and Reconstructive Surgery General Surgery• Orthopedic Surgery• Gynecological Surgery except as contraindicated for uterine fibroids.• Thoracic Surgery• Laparoscopic Surgery• Thoracoscopic Surgery
The system may also be combined with electrosurgery using optional RF surgery interface components.

2.2. Contraindications

2.2.1 The neXus Ultrasonic Surgical Aspirator System probe tips are not indicated for and should not be used for direct contact with cardiac tissue (direct cardiac application).

2.2.2 The irrigation pump is not indicated for and should not be used for the administration of parenteral fluids, infusion of drugs, or for any life sustaining purposes.

2.2.3 This neXus Ultrasonic Surgical Aspirator System device is not indicated for and should not be used for the fragmentation, emulsification, and aspiration of uterine fibroids.

3. Adverse Effects

WARNING The neXus Ultrasonic Surgical Aspirator System and its accessories may emit harmful acoustic pressure if exposure exceeds recommended limits.

Limits For Airborne Acoustic Exposure		
Distance from operator's or patient's ear		Maximum Exposure Period Within a 24-hour period
12"	30 cm	Not to exceed 9 minutes
24"	60 cm	Not to exceed 90 minutes
> 24"	> 60 cm	Not to exceed 240 minutes

Table 3.1: Limits for Airborne Acoustic Exposure

WARNING Tip and irrigation temperatures may exceed the tissue necrosis point if insufficient irrigation flow rates are used. For hard tissue removal, set the irrigation flowrate to a setting no less than the comparable vibration setting. For example, if the vibration setting is 70, a minimum flow setting of 70 should be used. Additional external irrigation, e.g. by administering sterile saline with a syringe over the distal tip portion, may be necessary for removal of very dense, hard osseous structures.

WARNING Tissue necrosis may result if tip is not moved relative to tissue. A continuous, lateral sweeping motion is recommended in order to minimize contact duration with the ultrasonic tip and minimize heat build-up. When lateral motion is not possible withdraw and re-insert tip frequently.

4. Handpiece Assembly and Disassembly

The handpiece assembly in the sterile field should be performed by trained and authorized OR staff only. Once the handpiece has been assembled, refer to the neXus Console Instructions For Use for connectivity with the system.

The SonaStar handpiece is available in two different configurations (short or long) that can be connected to a variety of probes for different applications. The tip choice is determined by the type of tissue being targeted and at the discretion of the user.

- | | |
|---------|--|
| CAUTION | The sterile wire stylet, torque wrench and torque fixture should be retained with the handpiece in the sterile field. |
| CAUTION | All reusable system components like handpiece, torque fixture and torque wrench are supplied industrially cleaned, but NON-STERILE. All items intended for use in the sterile field must be cleaned and sterilized as per the indicated instructions before first clinical use and before every subsequent clinical use. |
| CAUTION | All items intended for use in the sterile field must be cleaned and sterilized as per indicated instructions in Chapter 59 before each clinical use. |
| CAUTION | Do not attempt to tighten or loosen handpiece components by holding the handpiece case. Always place the handpiece into the torque fixture and use the torque wrench when tightening or un-tightening the tip. Do not over-tighten the tip. |
| CAUTION | All items intended for use in the sterile field must be cleaned and sterilized as per indicated instructions in Chapter 59 before each clinical use. |
| CAUTION | The disposable items are intended for one procedure only (single use). Do not attempt to reuse or re-sterilize. |
| WARNING | Use only sterilization cycles specified in this user manual. Do not use any other sterilization cycles. Improper sterilization can lead to handpiece or accessory damage, patient injury, or death. |

4.1. Items Required for Handpiece Assembly (Short & Long)

- SonaStar Handpiece (Short or Long)
- SonaStar Sterilization Tray
- SonaStar Counter Wrench
- SonaStar Torque Wrench
- Desired Procedure Pack
- Monopolar Handpiece Cable (if needed)

4.2. Handpiece Inspection (Short & Long)

Handpiece Inspection: Perform Inspection Prior To Use	
Inspect Handpiece	Inspect the handpiece housing and cable for any visual cracks. Inspect the front metallic portion for surface damage like nicks, gouges and cracks. Inspect the threads for signs of damage or excessive wear. Replace if damaged.
Inspect Mating Surface	Inspect mating face of handpiece and ultrasonic tip to verify that it is clean and dry.

Table 4.1: Handpiece inspection

4.3. SonaStar Long Handpiece Assembly

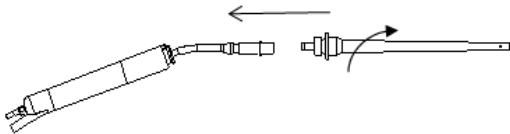
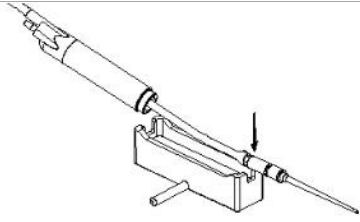
Handpiece Assembly – SonaStar Long Handpiece		
<p>1. Install the tip</p>	 <p>Insert the tip into the handpiece and hand tighten turning clockwise.</p>	
<p>2. Place handpiece into torque fixture</p>	 <p>Handpiece cable should be facing upward</p>	<p>Place hand over torque fixture and hold handpiece securely down in torque fixture to tighten ultrasonic tip.</p>

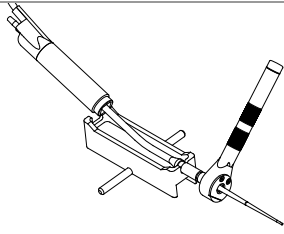
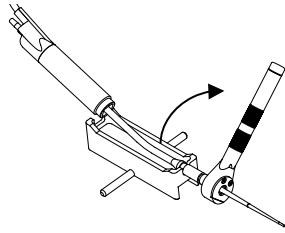
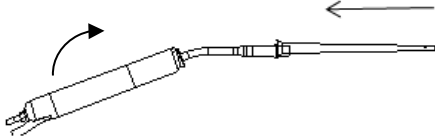
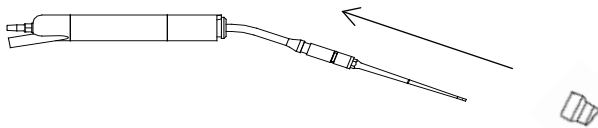
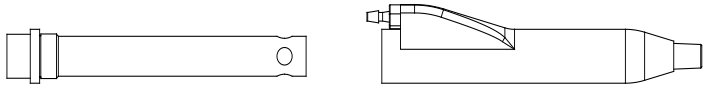
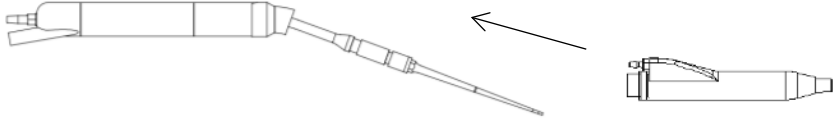
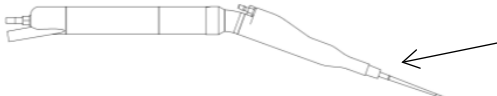
<p>3. Tighten the ultrasonic tip</p>	 <p>Slide torque wrench over tip, ensuring that text "Handpiece this side" faces the handpiece</p>	 <p>Rotate clockwise until two clicks are heard. Remove wrench.</p>
<p>4. Install the Mid-Housing</p>	 <p>Slide the Front Housing onto the handpiece and then tighten by turning clockwise.</p>	
<p>5. Mount silicone elbow</p>	 <p>Snap silicone elbow onto Mid-Housing and align with notch on silicone elbow</p>	
<p>6. Replace O-ring (if required)</p>	<p>Slide the small O-ring over the probe and into the groove of the front driver.</p> <p>Replacement of this O-ring is not required for each use. Replace only if O-ring becomes worn or damaged. Medical grade silicone lubricant may be used to lubricate this O-ring.</p>	
<p>7. Assemble housing tip assembly</p>	 <p>Screw together the inner and outer sleeves</p>	
<p>8. Install the rigid housing tip assembly</p>	 <p>Push the rigid tip assembly onto the silicone elbow until the silicone elbow makes contact with the shoulder of the rigid Housing tip assembly.</p>	
<p>9. Install the silicone sleeve</p>	 <p>Install the silicone sleeve (from the procedure tray) onto the rigid housing tip assembly.</p>	

<p>10. Attach the silicone tubing and O-ring</p>	 <p>Attach the smaller diameter tubing to the aspiration port on the front housing. Attach the larger diameter tubing to the blue connector on the rear of the handpiece. Slide the black O-ring over the handpiece up to the mid-section to secure the tubing.</p>
---	---

Table 4.2: SonaStar Long Handpiece Assembly

The SonaStar Long Handpiece is now ready for use and can be connected to the SonaStar System. Refer to the neXus Console Instructions For Use for connectivity with system.

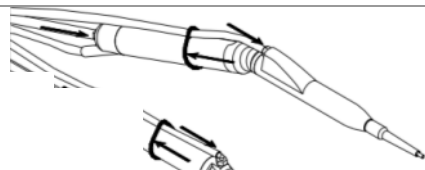

Figure 4.1: Fully assembled SonaStar Long Handpiece

4.4. SonaStar Short Handpiece Assembly

Handpiece Assembly – SonaStar Short Handpiece	
<p>1. Install the tip</p>	 <p>Insert the tip into the handpiece and hand tighten turning clockwise.</p>

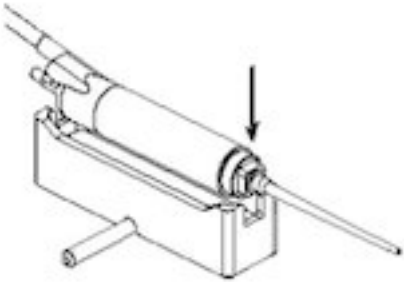
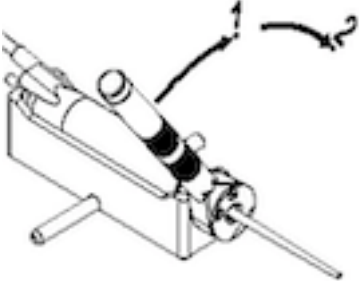
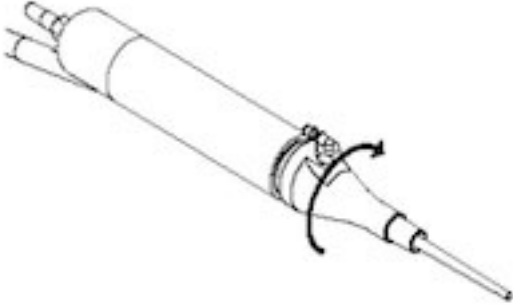
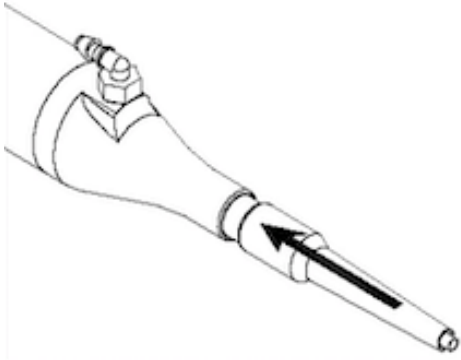
<p>2. Place handpiece into torque fixture</p>	 <p>Handpiece cable should be facing upward</p>	<p>Place hand over torque fixture and hold handpiece securely down in torque fixture to tighten ultrasonic tip.</p>
<p>3. Tighten the ultrasonic tip</p>		<p>Slide torque wrench over tip, ensuring that text "Handpiece this side" faces the handpiece</p> <p>Rotate clockwise until two clicks are heard. Remove wrench.</p>
<p>4. Install Front Housing</p>	 <p>Slide the Front Housing onto the handpiece and then tighten by turning clockwise.</p> <p>Refer to the disposable procedure pack for information on which Font Housing (Short or Long) should be used for the selected procedure pack.</p>	
<p>5. Install the silicone sleeve</p>	 <p>Install the silicone sleeve from the procedure pack onto the rigid housing tip assembly.</p>	

<p>6. Attach the silicone tubing and O-ring</p>	 <p>Attach the small diameter tubing to the aspiration port on the front housing. Attach the larger diameter tubing to the blue connector on the rear of the handpiece. Slide the black O-ring over the handpiece up to the mid-section to secure the tubing.</p>
---	---

Table 4.3: SonaStar Short Handpiece assembly

The SonaStar Short Handpiece is now ready for use and can be connected to the SonaStar System. Refer to the neXus Console Instructions For Use for connectivity with system.

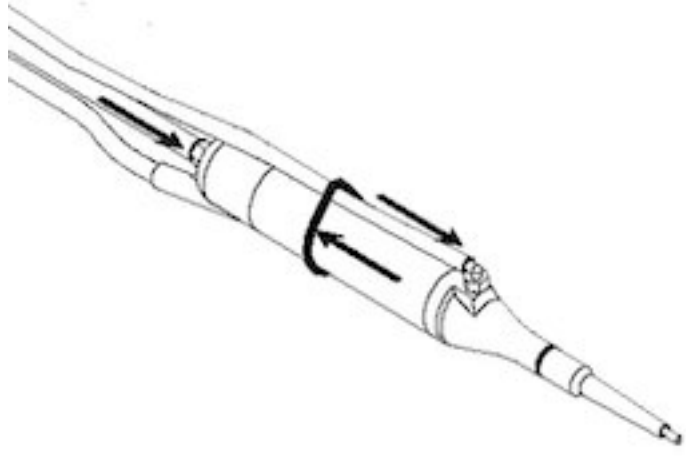

Figure 4.2: Fully assembled SonaStar Short Handpiece

4.5. Monopolar Guidelines

When using the electro-surgical generator in combination with the neXus System for monopolar electrocautery, refer to the electro-surgical generator user manual for detailed indications for use, modes of operation, instructions for use, contraindications, electro-surgical guidelines, cautions, warnings

When interfacing the neXus System with the electro-surgical generator, users should refer to the following warnings and cautions.

WARNING The neXus Long or Short Handpieces can deliver RF energy via its attached probe tip when connected to a 3rd party electro-surgical generator using the RF Monopolar Handswitch Cable accessory. Misonix recommends use of the electro-surgical generators listed in Table 4.5 that have been validated for compatibility with the neXus system.

- CAUTION The neXus system has been designed for use with an IEC60601-1 and IEC60601-2-2 compliant electrosurgical generators in the monopolar coagulation mode (COAG) only. Cut mode (CUT) cannot be activated when using the Misonix monopolar cable.
- WARNING DO NOT use any electrosurgical device that exceeds a peak electrosurgical output of 4.5KV in the coagulation mode (COAG) to avoid electrical shock.
- CAUTION Misonix recommends staying within the limits prescribed by the electrosurgical generator's user manual for the type of procedure being performed, up to a maximum power setting of 70 W. Generally, the lowest setting that proves effective for the procedure being performed should be used to avoid arching.
- CAUTION Studies have shown that smoke generated during electrosurgical procedures can be potentially harmful to patients and the surgical team. These studies recommend adequately ventilating the smoke by using a surgical smoke evacuator or other means. Refer to the 3rd party electrosurgical generators user manual for more information regarding the evacuation of smoke.
- WARNING Improper connection of the RF monopolar fingerswitch cable may present a shock hazard. always use gloved, dry hands when plugging it in to the electrosurgical generator and handpiece.
- WARNING Always place the neXus SonaStar handpiece with the monopolar handpiece cable attached on a nonconductive surface when not in use for monopolar cautery.
- WARNING Always use the lowest possible generator setting that will achieve the desired cauterization effect. When higher than necessary voltages are used, the potential for arching are increased.
- WARNING Clean the neXus SonaStar tip frequently when using the tip for electrocautery. As eschar builds up on the tip, electrical impedance increases, and this can cause arching, sparking or ignition and flaming of the eschar. Clean with a nonabrasive sterile pad to prevent scratching of the probe tip. Scratch groves will increase eschar build up and can effect ultrasonic surgical performance of the tip.
- WARNING Do not wrap the neXus monopolar cable around metal instruments with sharp corners or features that can damage the cable and cause leakage current.

The neXus Long or Short Handpieces can deliver RF energy via its attached probe tip when connected to a 3rd party electro-surgical generator using the RF Monopolar Handswitch Cable accessory. Misonix recommends use of the electro-surgical generators listed in Table 4.5 that have been validated for compatibility with the neXus system.

RECOMMENDED/COMPATIBLE ELECTROSURGICAL SYSTEMS	
MAKE	MODEL
Valleylab FT10	VLFT10GEN
Force2 /Force FX	FORCE FX-C
ForceTriad	ForceTriad
System 5000	60-8005-SYS
VIO-300 D	10140-100

Table 4.5

The RF energy is delivered via a sterile, single use RF Monopolar Handswitch Cable accessory that contains a hand switch that is used to facilitate the energization of the RF output.

With the use of the sterile, single use RF Monopolar Handswitch Cable accessory, the neXus system can interface with 3rd party electro-surgical systems to provide monopolar electrocautery directly through the titanium probe tip thus enabling the surgeon to cauterize bleeding vessels without having to change instruments. The monopolar accessory cable contains a hand switch that is used to facilitate the energization of the RF output. The diagram below shows how to connect the neXus Long or Short Handpieces to the 3rd party electro-surgical system. All user settings for the 3rd party electro-surgical system are independently set using its user interface. The neXus console/generator does not control any of the operational parameters of the 3rd party electro-surgical system.

Although electro-surgical devices support bipolar and monopolar instruments, as well as CUT and COAG modes, the Misonix single use monopolar cable is designed for use in monopolar COAG mode only. CUT mode cannot be activated when using the Misonix monopolar cable.

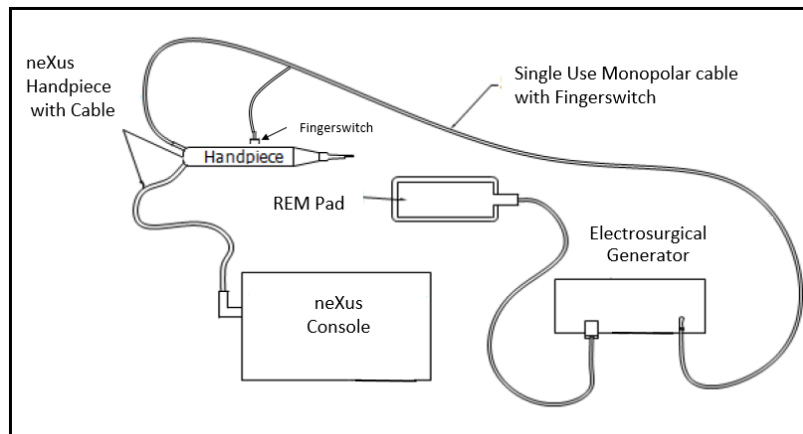

CAUTION The neXus system has been designed for use with an IEC60601-1 and IEC60601-2-2 compliant electrosurgical generators in the monopolar coagulation mode only. Cut mode cannot be activated when using the neXus Monopolar Handswitch Cable.

The items needed for interfacing a Sonastar handpiece with an RF electrosurgical device are listed below (see section 4.6 and 4.9 for assembly and disassembly):

REF Number	Description	QTY
100-29-0000	Single Use Monopolar Hand switch cable	1

4.6. Electrosurgery Handswitch Assembly

The electrosurgery connector is located on the rear cap of the handpiece, adjacent to the cable strain relief. For electrosurgery capability, plug the appropriate end of the Single-Use Monopolar Handswitch Cable into the handpiece end, as shown in below.

The Single-Use Monopolar Handswitch Cable can be used with BOTH the SonaStar Short Handpiece and the SonaStar Long Handpiece.

-
- WARNING** Improper assembly of Single-Use Monopolar Handswitch Cable to endcap can expose potentially dangerous electrosurgery voltage. To avoid poor electrical connection, always make sure the Single-Use Monopolar Handpiece Cable socket is firmly and fully engaged onto the pin in the endcap. Inspect the silicone sleeve near the probe tip for cracks that may expose the probe (active electrode).
- WARNING** Ensure that the aspiration tubing is fully seated onto the Aspiration Port in the base of the handpiece.
- WARNING** Prior to and during use, inspect the Monopolar Handswitch Cable for possible damage (i.e. cracks in cable jacket).
- CAUTION** Monopolar Handswitch Cable is supplied sterile and is NOT sterilizable.
- CAUTION** Position Monopolar cable to avoid contact with the patient or any other leads.
- CAUTION** After use with electrosurgical device, store unused handpiece probe tip in a location isolated from the patient.



Insert connector into back of SonaStar Handpiece (Short or Long) endcap.

Figure 4.3: Monopolar Handswitch Handpiece Cable Connection



Install actuation button onto the SonaStar Handpiece (Short or Long) housing.

Figure 4.4: Monopolar Handswitch Housing Connection



Insert electro-surgical connector into electro-surgical generator. Note; generator maximum output voltage not to exceed 4.5kV peak. Output power should be set as low as possible for the intended use.

Figure 4.5: Monopolar Handswitch Electro-surgical Cable Connection

4.7. SonaStar Long Handpiece Disassembly

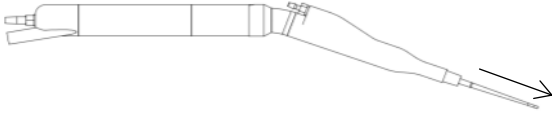
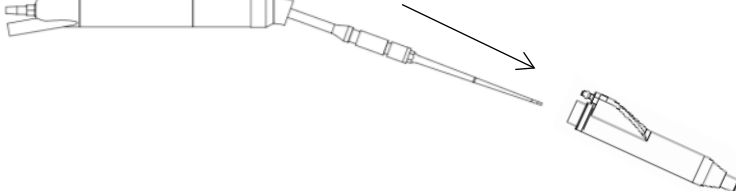
<p>1. Remove the O-ring from the handpiece and disconnect the tubing from the handpiece connector and the aspiration port</p>	
<p>2. Remove the silicone sleeve</p>	 <p>Remove the silicone sleeve from the rigid housing tip assembly.</p>
<p>3. Remove the rigid housing tip assembly</p>	 <p>Pull the rigid housing tip assembly from the silicone elbow (do not discard).</p>



<p>4. Disassemble housing tip assembly</p>	 <p>Unscrew the inner sleeve from the outer sleeve and separate from housing (do not discard).</p>	
<p>5. Remove silicone elbow</p>	 <p>Pull the silicone elbow from the handpiece (do not discard).</p>	
<p>6. Remove the Mid-Housing</p>	 <p>Turn the front housing counter clockwise and slide over the tip to remove (do not discard).</p>	
<p>7. Place handpiece into torque fixture</p>	 <p>Handpiece cable should be facing upward.</p>	
<p>8. Loosen the ultrasonic tip</p>	 <p>Slide torque wrench over tip, ensuring that text "Handpiece this side" faces the handpiece.</p>	 <p>Rotate counter clockwise until the tip is loosened. Remove wrench.</p>
<p>9. Remove the tip</p>	 <p>Hand loosen and remove the tip by turning counter clockwise.</p>	

Table 4.1: SonaStar Long Handpiece Disassembly

4.8. SonaStar Short Handpiece Disassembly

1. Remove the O-ring from the handpiece and disconnect the tubing from the handpiece connector and the aspiration port		
2. Remove the silicone/rigid sleeve from the front housing		
3. Remove the plastic front housing from the handpiece (front housing varies based upon tip selection)		
4. Remove the tip	 <p>Place the handpiece into the torque fixture (cable should be facing upward).</p>	
5. Loosen the ultrasonic tip	 <p>Slide torque wrench over tip, ensuring that text "Handpiece this side" faces the handpiece.</p>	 <p>Rotate counter clockwise to loosen the tip. Remove wrench.</p>
6. Remove the Tip	Hand loosen and remove the tip by turning counter clockwise.	

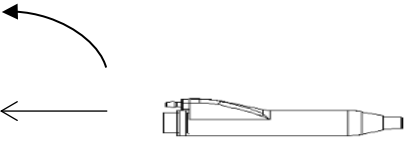
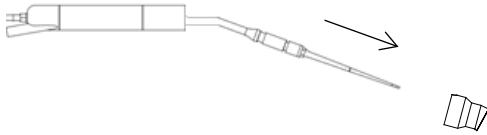
Table 4.5: SonaStar Short Handpiece Disassembly

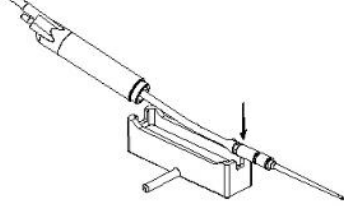
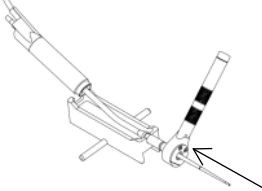
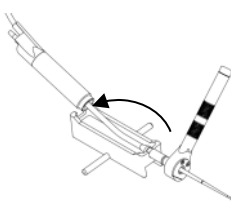
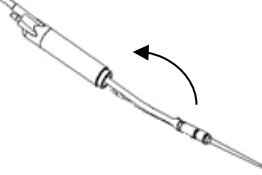
4.9. Electrosurgery Handswitch Assembly Disassembly

The electrosurgery connector is located on the rear cap of the handpiece, adjacent to the cable strain relief. For electrosurgery capability, plug the appropriate end of the Single-Use Monopolar Handswitch Cable into the handpiece end, as shown in below.

The Single-Use Monopolar Handswitch Cable can be used with BOTH the SonaStar Short Handpiece and the SonaStar Long Handpiece.

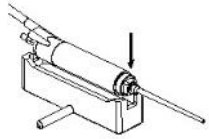
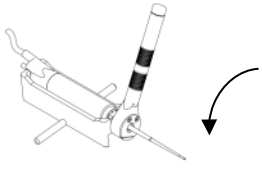
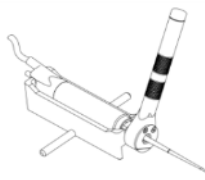
WARNING Improper assembly of Single-Use Monopolar Handswitch Cable to endcap can expose potentially dangerous electrosurgery voltage. Always make sure the Single-Use Monopolar Handpiece Cable socket is firmly and fully engaged onto the pin in the endcap.

WARNING Ensure that the aspiration tubing is fully seated onto the Aspiration Port in the base of the handpiece.

CAUTION Monopolar Handswitch Cable is supplied sterile and is NOT sterilizable.



Remove connector from the back of the SonaStar Handpiece (Short or Long) endcap.

Figure 4.5: Monopolar Handswitch Handpiece Cable Connection



Remove the actuation button from the SonaStar Handpiece (Short or Long) housing.

Figure 4.6: Monopolar Handswitch Housing Connection



Remove the electro-surgical connector from the electro-surgical generator.

Figure 4.7: Monopolar Handswitch Electro-surgical Cable Connection

5. Cleaning and Sterilization

Follow manufacturer's directions for preparing cleaning and sterilization. Misonix recommends the use of CaviWipes® or equivalent quaternary ammonium compound surface disinfectant wipe. Please follow manufacturer's instructions for surface cleaning and disinfection of hard non-porous surfaces, including, without limitation, the use of personal Protection Equipment (PPE) for blood borne Pathogens. Dispose of the used wipes in accordance with local regulations regarding the disposal of biological hazardous wipes.

Dispose of Single-Use Items

All items marked single use must not be reused. Reuse of these items could result in severe patient injury or death.

Once used, dispose of single use items in accordance with standard hospital procedures for disposal of biohazardous waste.

WARNING	Remove probe cover, ultrasonic tip and extension from the handpiece prior to cleaning and/or sterilization; otherwise proper cleaning/sterilization may be inhibited.
WARNING	Single-use items (tips, sheaths, tubing sets) are marked with the international symbol for "do not reuse - single use only" (☒). Discard these items following each surgical procedure in accordance with the hospital protocol for biohazardous waste. Tips are to be disposed of in a biohazardous sharps container.
WARNING	The disposable items are intended for one procedure only (single use). Do not attempt to reuse or re-sterilize.

The following items are considered reusable items and should be cleaned as recommended:

- SonaStar Handpiece (Long and/or Short)
- SonaStar Counter Wrench
- SonaStar Torque Wrench
- SonaStar Mid-Housing
- SonaStar Front Housing (Short)
- SonaStar Front Housing (Long)
- SonaStar Probe Cover Assembly
- SonaStar Silicone Connector
- Universal Handpiece Sterilization Case

Misonix Inc. has validated the cleaning procedures outlined below.

Misonix continually updates its sterilization and cleaning instructions as required. For the latest instructions and reuse recommendations please contact your local Misonix representative.

WARNING	All reusable handpiece parts and accessories must be properly decontaminated, cleaned and sterilized before each use as per instructions contained in this manual. Failure to do so may lead to transmission of disease.
WARNING	Do not use flammable agents for cleaning or disinfecting.

WARNING

Misonix Inc. has validated all cleaning and sterilization cycles for reusable items in this manual. To prevent transmission of disease or malfunction of the neXus® system, Misonix recommends that the procedures given in this manual for cleaning and sterilizing the neXus® Ultrasonic Surgical Aspirator System and related accessories be followed. Misonix does not prefer the validated cleaning agents, cleaning procedures or sterilization procedures over others that are available. Other cleaning agents, cleaning procedures and/or sterilization cycles may have equal or superior performance. However, alternatives must be verified by reviewing the product information from the cleaning agent supplier and/or by physical and microbiological testing in accordance to applicable global regulatory guidance on cleaning and sterilizing reusable medical devices in the health care environment.

5.1. Manual Cleaning/Washing Procedure

Wrenches	
Wash & Brush	<ul style="list-style-type: none"> Wash items with hot water mixed with an enzymatic detergent such as ASP Enzol® or Steris Prolystica® according to standard hospital protocol. Follow manufacturer’s directions for preparing solutions. Probe cover and wrenches may be fully immersed. Brush all passages at least four (4) times from FRONT to REAR, rotating the brushes during insertion and inserting the brushes fully. This ensures clearing of debris from the internal passages. Item’s exterior surface can be cleaned using a standard soft bristle cleaning brush.
Rinse	<ul style="list-style-type: none"> Rinse item under warm running water for a minimum of 1 minute to clear soap residue.
Dry	<ul style="list-style-type: none"> Dry item fully with absorbent towel or paper. Dispose of cloth or paper in accordance with Hospital or Clinic practices for contaminated wastes.
Inspect	<ul style="list-style-type: none"> Inspect wrenches and remove any item which shows signs of damage (cracks, gouges, fractures etc.). Mark damaged items clearly to prevent future use before disposal.
Post Cleaning	<ul style="list-style-type: none"> Inspect all items for cleanliness and damage following cleaning and prior to terminal sterilization.

Table 5.1 Cleaning of Probe Cover and Wrenches

Handpiece (Short & Long), Front Housing(s), Silicone Connector	
Wipe Cable	<ul style="list-style-type: none"> Wipe cable with cloth or absorbent paper moistened with an enzymatic detergent such as ASP Enzol® or Steris Prolystica®. Follow manufacturer’s directions for preparing solutions. Clean all surfaces of bloodstains and obvious signs of contamination.
Wash & Brush	<ul style="list-style-type: none"> Wash and brush handpiece with hot water mixed with an enzymatic detergent such as ASP Enzol® or Steris Prolystica®. Follow manufacturer’s directions for preparing solutions. The handpiece cannot be immersed. Brush all passages at least four (4) times from FRONT to REAR, rotating the brushes during insertion and inserting the brushes fully. This ensures clearing of debris from the internal passages. Brush the cavity surrounding the electrosurgery pin molded in the rear (proximal) end of the handpiece cavity which is 1.3mm (0.05”) x 10.1mm (0.40”) in addition to any other cavities visible on the handpiece. The item’s exterior surface can be cleaned using a standard soft bristle cleaning brush.

Rinse	<ul style="list-style-type: none"> Rinse item under warm running water for a minimum of 1 minute to clear soap residue.
Dry	<ul style="list-style-type: none"> Dry item fully with absorbent towel or paper. Dispose of cloth or paper in accordance with Hospital or Clinic practices for contaminated wastes.
Inspect	<ul style="list-style-type: none"> Inspect handpiece and cable and remove any item which shows signs of damages (cracks, gouges, fractures etc.). Mark damaged items clearly to prevent future use before disposal.
Post Cleaning	<ul style="list-style-type: none"> Inspect all items for cleanliness and damage following cleaning and prior to terminal sterilization.

Table 5.2 Cleaning of Handpiece(s), Front Cover(s), and Silicone Connector

5.2. Automated Cleaning/Washing Procedure

Handpiece (Short & Long), Front Housing(s), Silicone Connector, and Wrenches	
Point of Use	<p>Immediately following procedure perform the following:</p> <ul style="list-style-type: none"> Flush handpiece lumen with minimum 100 mL of saline to clear the bore of debris. Wipe all reusable devices to remove visible blood and debris. <p>CAUTION: DO NOT use saline to wet the tray and tray contents before transport to the decontamination processing area.</p> <p>CAUTION If transport to the decontamination processing area is delayed, cover the tray with a damp cloth or spray the tray and its contents with a pre-cleaning foam. The pre-cleaning foam will minimize the drying of soil and facilitate later decontamination processing.</p>
Pre-Cleaning	<p>The following should be performed on a disassembled handpiece:</p> <ul style="list-style-type: none"> Prepare neodisher® MediClean forte at 3.9 mL per liter of water (5/8 oz. per gallon water). Water should be lukewarm (<40°C, <104°F). Use a tight-fitting brush dipped in the prepared cleaning solution to clean the cavity surrounding the electrosurgery pin molded in the proximal end of the handpiece in addition to any other cavities visible on the handpiece. Use a tight-fitting brush dipped in the prepared cleaning solution to clean the lumen of the handpiece by inserting the brush fully through the lumen until visible from the other side a minimum of four times, rotating the brush as it is inserted. Rinse all residual soap from the handpiece under warm running water for a minimum of one minute. Visually inspect internal and external surfaces of the handpiece including the pin cavity and repeat the above steps as required until all visible debris and staining are removed.
Automated Wash and Disinfection	<p>When placing the handpiece into the automated washer, place on the top shelf of the washer. Attempt to align the lumen in the general direction of the water jet flow in the washer but at a slight angle to facilitate draining during the drying cycle.</p> <p>Process the handpiece and all reusable components and accessories using the cycle parameters, in the table below. <i>*Durations listed are minimum acceptable. Longer durations than those specified for cleaning and disinfection are acceptable.</i></p>
Post-Cleaning	<p>Inspect all items for cleanliness and damage following cleaning and prior to terminal sterilization.</p>

Table 5.3: Cleaning of Handpiece(s), Front Cover(s), Silicone Connector, and Wrenches

Phase	Time*	Parameters	Detergent Type and Concentration
Pre-Wash 1	2 minutes	Cold tap or purified water	None
Wash 1	2 minutes	≥65.5°C (150°F)	neodisher® MediClean forte 2mL/L (¼ oz. / gallon)
Rinse 1	1 minute	Hot tap water	None
Disinfection	1 minute	≥90°C (194°F)	None
Drying	6 minutes	≥98.8 °C (210°F)	None

Table 5.4: Automated Wash Cycle Parameters (* Durations listed are minimum acceptable. Longer durations than those specified for cleaning and disinfection are acceptable.)

CAUTION Do not use ultrasonic cleaners to clean the handpiece as this method could damage the handpiece.

CAUTION Be certain to clear debris from all internal passages by brushing. Failure to do so may hinder sterilization of units during autoclaving.

CAUTION Do not immerse ultrasonic console, handpiece, irrigation pump, remote footswitch or electric cables. These items are not sealed against liquids and damage to equipment will result.

5.3. Sterilizing by Steam Autoclave

Sterilization Methods and terminology are based on ANSI/AAMI ST81 and EN ISO 17664:2004 standards.

Reusable, Autoclavable Components

100-25-0001	Long Handpiece
100-24-0001	Short Handpiece
100-62-0000	Handpiece Counter Wrench
100-63-0000	Handpiece Torque Wrench
100-25-0002	Mid-Housing (long)
100-24-0003	Short Housing (Short)
100-25-0003	Front Housing (Long)
100-71-0000	Universal Handpiece Sterilization Case

Table 5.5: SonaStar (Short & Long) Handpiece Reusable, Autoclavable Components

Handpiece **DISASSEMBLED** using Misonix Sterilization Tray: Probe, Tubing, and Housing should be REMOVED.

	132°C (270°F)	134-137°C (274-279°F)
Configuration	Items placed in Misonix Sterilization Tray # 100-71-0000 ¹	Items placed in Misonix Sterilization Tray # 100-71-0000 ¹
Cycle	Prevacuum	Prevacuum
Preconditioning Pulses	4	4
Minimum Exposure Time	8 minutes*	4 minutes*
Minimum Dry Time	30 minutes	30 minutes

Table 5.6: Sterilization Parameters for Handpiece **DISASSEMBLED** using Misonix Sterilization Tray

Handpiece **DISASSEMBLED** without Sterilization Tray, Items Wrapped: Probe, Tubing, and Housing should be REMOVED.

	132°C (270°F)	134-137°C (274-279°F)
Configuration	Items wrapped, No Tray ²	Items wrapped, No Tray ²
Cycle	Prevacuum	Prevacuum
Preconditioning Pulses	4	4
Minimum Exposure Time	4 minutes*	3 minutes*
Minimum Dry Time	45 minutes	30 minutes

Table 5.7: Sterilization Parameters for Handpiece **DISASSEMBLED** without Sterilization Tray, Items Wrapped

CAUTION Allow reusable, autoclavable items to gradually return to room temperature after steam sterilization and prior to usage

¹ Tray wrapped in Kimberly Clark KC300 KIMGUARD sterilization wrap.

² No Tray. Wrapped in Kimberly Clark KC300 or KC600 KIMGUARD sterilization wrap.

*Exposure time can be increased up to a maximum of 18 minutes to comply with local requirements and/or recommendations of the World Health Organization (WHO), Robert Koch Institute (RKI), etc. Misonix Inc reusable medical devices are able to sustain such sterilization cycles.

Deviations from Decontamination, Cleaning and Sterilization Instructions

Misonix Inc. has validated all cleaning, disinfection and sterilization cycles given in this manual. It is highly recommended that the procedures given in this manual for cleaning and sterilizing the NeXus® Ultrasonic Surgical Aspirator System and related accessories be followed. It is the responsibility of the user of this device or any accessories used with it to validate procedures for cleaning and/or sterilization if they differ from the procedures as outlined in this manual.

Technical Assistance: Should the user wish further information or instructions regarding any aspect of cleaning or sterilizing procedures, please contact Misonix Inc. or an Authorized Representative.

5.4. Expected Life, Reusable Components

All handpiece components need to be examined regularly, prior each use and be replaced if damaged.

The estimated sterilization life of handpiece components is listed below. All sterilization life estimates are approximate and may be affected by rough handling, damage, wear due to vigorous cleaning, etc.

Estimated Sterilization Life	
Item	Number Of Steam Sterilization Cycles
Handpiece with attached cable	~200 cycles
Probe covers	~ 300 cycles
Wrenches: Handpiece/counter wrench and torque wrench	~300 cycles
Handpiece with attached cable and monopolar	~200 cycles

Table 5.9 Reusable Component Estimated Re-Use Life

CAUTION The reuse life given considers wear and tear due to cleaning and sterilization only. Damage or wear caused by actual use in treatments will affect life of components.

WARNING The disposable items are intended for one procedure only (single use). Do not attempt to reuse or re-sterilize.

5.5. Handpiece Specifications

SonaStar Short Handpiece	
Operating frequency	23 kHz
Cable length	17' 5.2 m
Dimensions	4.8" L (without probe) x 0.8" D 13 cm x 2.0 cm
Weight with tip	3.2 oz. 91 g
SonaStar Long Handpiece	
Operating frequency	23 kHz
Cable length	17' 5.2 m
Dimensions	9.5" L (without probe) x 0.8" D 24.1 cm x 2.0 cm
Weight with tip	4.16 oz. 118 g

Table 5.10: Handpiece Specifications

6. Repair, Service and Replacement Parts

All requests for repairs and replacement parts should be directed to Misonix or an authorized Misonix representative. Always provide model and serial number of malfunctioning items.

When returning items include model, serial and RMA number as well as purchase order number on all documents. Always prepay return shipping and specify method of shipment.

WARNING No Modifications of this equipment is allowed except as noted for cleaning and sterilization. The user should return to Misonix or an authorized service center

7. Important Notice

Please contact Misonix with any questions regarding the specifications, use, sterilization, limitations or maintenance of the NeXus® Ultrasonic System:

	Misonix, Inc.
Web	www.misonix.com
Phone	+1.631.694.9555 / 1-800-694-9612
Fax	+1.631.694.9412
Address	1938 New Hwy Farmingdale, NY 11735 U.S.A.

By returning any material to Misonix, Inc. the customer or the customer's agent must certify that any and all materials so returned are or have been rendered free of any hazardous or noxious matter or radioactive contamination and are safe for handling under normal repair shop conditions.

Do not return any material for which such certification cannot be made without prior approval from

Misonix, Inc. The correct return address should read as follows:

MISONIX (Misonix, Inc.)
Medical Service Department
RMA # _____
1938 New Hwy
Farmingdale, NY 11735
U.S.A.

Please contact Misonix for a list of other authorized service centers.

The authorized EC representative is:



EMERGO EUROPE
Prinsessegracht 20
2514 AP The Hague
The Netherlands